

**POMPE A MANO
CON VALVOLA DI SICUREZZA
HAND PUMPS WITH SAFETY VALVE**

SERIE
SERIES

**PMS+VS
12-25-45**

Codice fascicolo: 997-400-10610

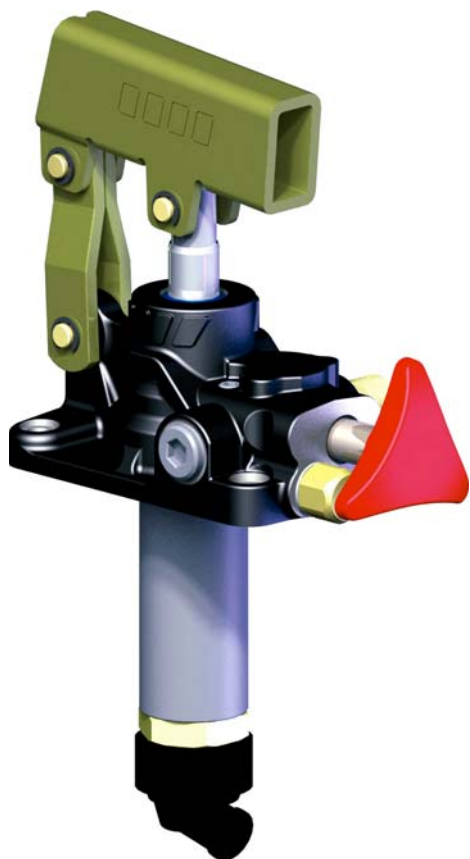

Pompe a mano con azionamento a doppio effetto (la pompa eroga olio sia spingendo che tirando la leva) per impianti a semplice effetto, direttamente flangiabili su serbatoio e con rubinetto di scarico a tenuta conica incorporato. Sono disponibili in tre diverse cilindrate per consentire le più svariate applicazioni e per limitare lo sforzo sulla leva in ogni situazione. Hanno il corpo in ghisa sferoidale con trattamento in cataforesi anticorrosione e lo stelo nichelato.

Double acting hand pumps (the pump delivers oil both pushing and pulling the lever) suitable to operate single acting applications. They can be fitted also onto tank and are equipped with tapered lowering valve.

These hand pumps can have 3 different sizes to perform various applications and to achieve smoother loads on the lever. They are available with nodular cast-iron body with cathaphoresis anti-corrosion treatment and nickel-plated spool.

Data: Lunedì 04 ottobre 2010

Codice foglio: 997-106-01010 Rev.: AF

		Codice di ordinazione (senza leva) Order code (without lever)		
		FULCRO 12	FULCRO 25	FULCRO 45
Senza Serbatoio Without Tank		106-019-00013	106-010-00012	106-010-00021
	Con serbatoi With Tank Litri / Litres			
	1	106-018-00014	106-008-00016	106-009-00060
	2	106-018-00023	106-008-00025	106-009-00051
	3	106-018-00032	106-008-00034	106-009-00015
	5	106-018-00041	106-008-00043	106-009-00024
	7	106-018-00050	106-008-00052	106-009-00033
	10	106-018-00069	106-008-00061	106-009-00042



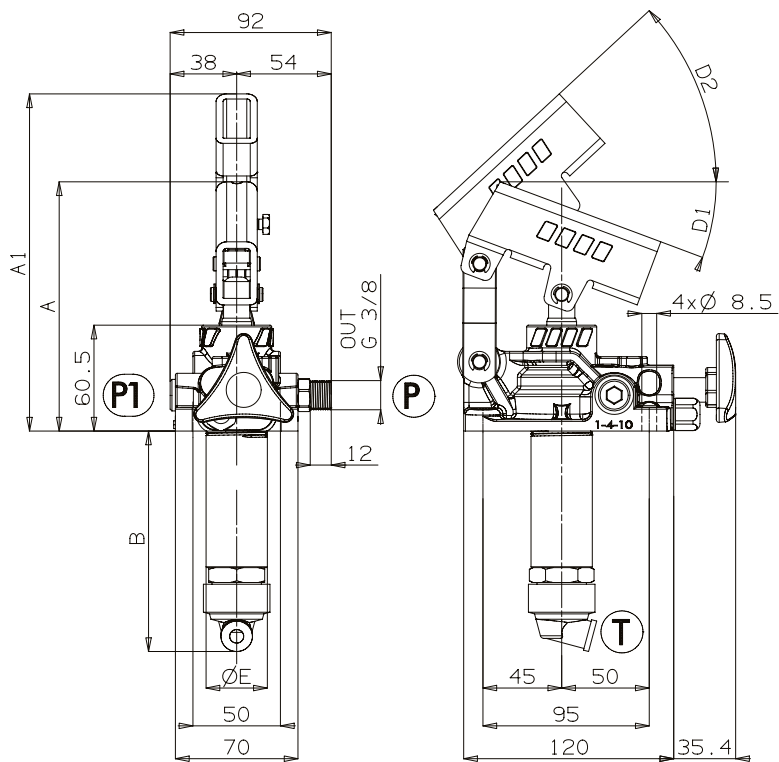
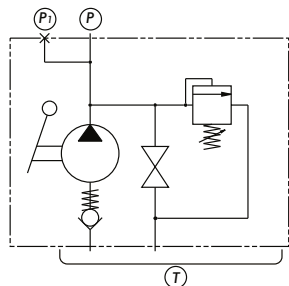

Ingombro
Overall Dimension

	A	A1	B	D1	D2	E
	mm	mm	mm	°	°	mm
FULCRO 12	143	187	120	18,5	45	35
FULCRO 25	142	193	127	20	45	35
FULCRO 45	141	193	138	20	45	42

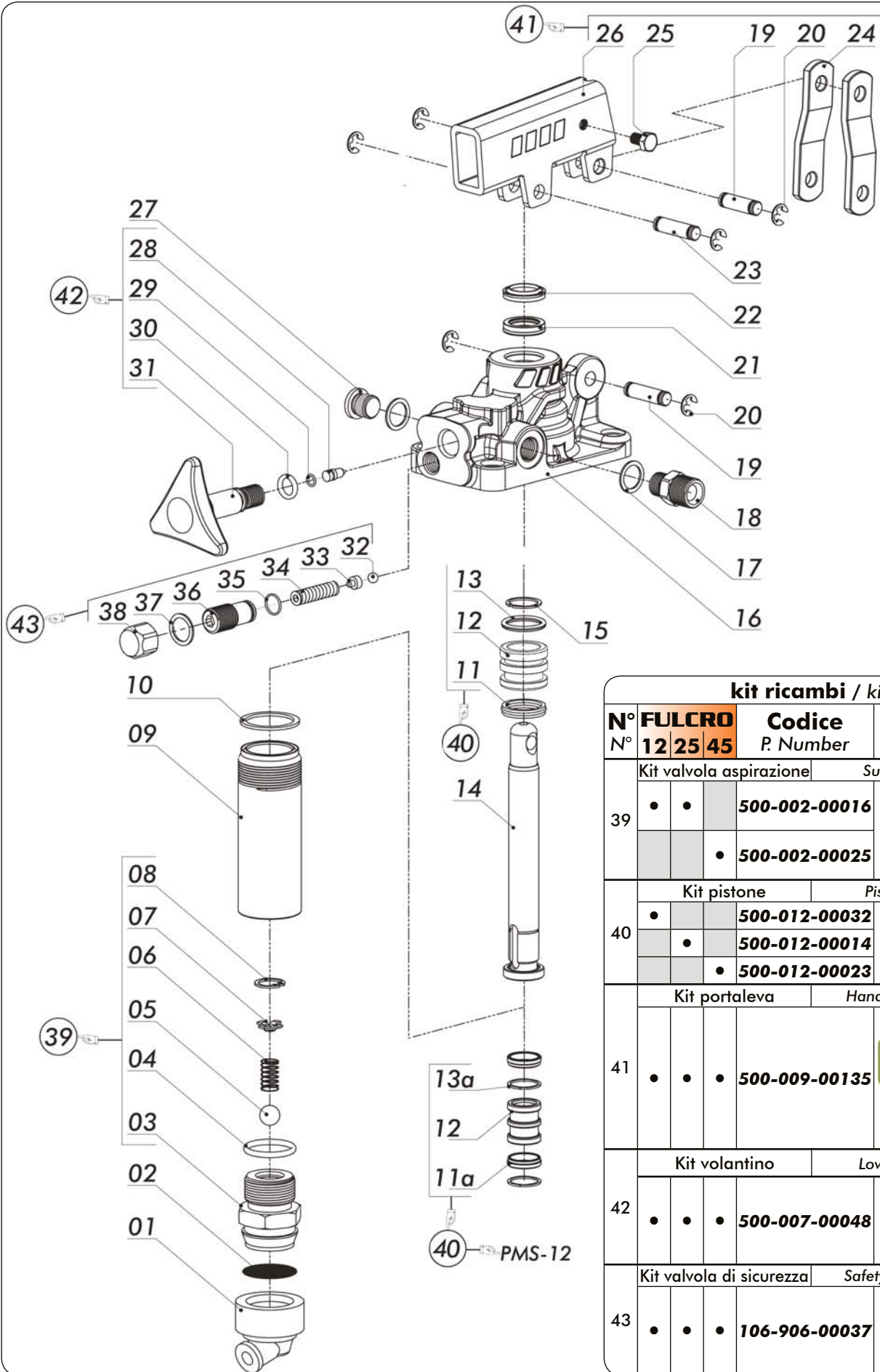
Schema Idraulico
Hydraulic layout





kit ricambi / kit's			
N°	FULCRO	Codice	Gruppo
N°	12 25 45	P. Number	Assembly
39		Kit valvola aspirazione	Suction valve kit
		• • • 500-002-00016	
		• 500-002-00025	
40		Kit pistone	Piston assembly
		• • • 500-012-00032	
		• 500-012-00014	
		• 500-012-00023	
41		Kit portaleva	Hand lever holder kit
		• • • 500-009-00135	
42		Kit volantino	Lowering valve kit
		• • • 500-007-00048	
43		Kit valvola di sicurezza	Safety valve assembly
		• • • 106-906-00037	

Codice fascicolo: 997-400-10610

Data: Lunedì 04 ottobre 2010

Codice foglio: 997-106-01010 Rev: AF

N° N°	FULCRO			Codice P. Number	Descrizione Description	Quantità Quantity	
	12	25	45				
1	•	•	•	506-000-00392	Guarnizione portafiltro	Suction cap	1
2	•	•	•	550-001-00012	Filtro acciaio rotondo	Steel strainer	1
3	•	•	•	540-005-00019	Corpo valvola di aspirazione	Suction valve casing	1
				540-005-00037			
4	•	•	•	506-002-00201	Guarnizione OR	O-ring	1
				506-003-00095			
5	•	•	•	510-009-00116	Sfera tenuta	Ball	1
6	•	•	•	512-005-00689	Molla valvola di aspirazione	Spring for suction valve	1
7	•	•	•	550-001-00101	Guidamolla	Spring-guide	1
8	•	•	•	501-001-00113	Anello elastico	Circlip	1
9	•	•	•	537-002-00037	Cilindro acciaio	Steel stem	1
				537-002-00019			
				537-002-00028			
10	•	•	•	116-009-01255	Rondella tenuta cilindro	Washer	1
				116-009-01308			
11a	•	•	•	506-000-00516	Guarnizione speciale	Special gasket	2
11	•	•	•	506-000-00258	Guarnizione speciale	Special gasket	1
				506-000-00267			
12	•	•	•	532-002-00082	Pistone	Piston	1
				532-002-00028			
				532-002-00037			
13a	•	•	•	550-004-00046	Anello antiestrusore	Locking ring	2
13	•	•	•	506-002-00158	Guarnizione OR	O-ring	1
				506-002-00229			
14	•	•	•	535-001-00121	Stelo	Piston rod	1
				535-001-00069			
				535-001-00078			
15	•	•	•	501-011-00086	Anello elastico	Circlip	1
				501-011-00111			
				501-011-00148			
16	•	•	•	517-001-00567	Corpo pompa a mano	Hand pump housing	1
				517-001-00585			
				517-001-00601			
17	•	•	•	116-009-00158	Rondella utilizzi	Washer	2
18	•	•	•	116-006-00259	Nipplo utilizzi	Pressure nipple	1
19	•	•	•	526-001-00095	Spinotto lunghezza 26mm	Gudgeon Pin 26mm	2
20	•	•	•	501-015-00028	Anello elastico	Circlip	6
21	•	•	•	506-000-01640	Guarnizione a labbro	Lip seal	1
				506-000-01659			
				506-000-01668			
22	•	•	•	506-000-01613	Guarnizione raschiapolvere	Wiper seal	1
				506-000-01622			
				506-000-01631			
23	•	•	•	526-001-00086	Spinotto	Gudgeon Pin	1
24	•	•	•	538-001-00081	Biella	Brackets	2
25	•	•	•	502-002-00012	Vite blocco leva	Locking lever screw	1
26	•	•	•	539-001-00212	Portaleva	Lever holder	1
27	•	•	•	115-006-00117	Tappo utilizzo	Pressure port plug	1
28	•	•	•	543-004-00023	Spillo tenuta	Pin	1
29	•	•	•	506-000-00589	Guarnizione OR	O-ring	1
30	•	•	•	506-002-00014	Guarnizione OR	O-ring	1
31	•	•	•	500-001-00357	Volantino	Lowering wheel	1
32	•	•	•	510-009-00045	Sfera tenuta valvola di sicurezza	Safety valve sealing ball	1
33	•	•	•	542-001-00073	Guidamolla	Spring-guide	1
34	•	•	•	512-005-01428	Molla valvola di massima	Spring	1
35	•	•	•	506-019-10102	Anello	O-ring	1
36	•	•	•	504-000-00458	Grano registro valvola di sicurezza	Setting screw for safety valve	1
37	•	•	•	116-009-00201	Rondella tenuta valvola di massima	Washer	1
38	•	•	•	540-006-00116	Tappo chiusura valvola di sicurezza	Safety valve cover	1

Dati Tecnici Technical data

Tipo pompa Pump type	Taratura standard Standard pressure setting	Taratura massima Max. pressure setting	Cilindrata Displacement			Peso Weight
			Completa / Full cm ³	Tiro / Pull cm ³	Spinta / Push cm ³	
FULCRO 12	160 bar	300 bar	12	6,1	5,9	2,8 Kg
FULCRO 25	160	300	25	13,4	11,6	2,9
FULCRO 45	160	270	45	23,7	21,3	3,2

Fluido idraulico Fluid	Minerale o sintetico compatibile con guarnizioni: Mineral or synthetic compatible with the following seals: NBR, FKM, FPM, Nylon				
Viscosità cinematica consigliata Kinematic viscosity suggested	T media ambiente (°C) Average ambient temp. (°C)	< -10	-10÷10	10÷35	> 35
	VG (cSt = mm ² /s)	22	32	46	68
Pres. di aspirazione Inlet pressure		-0,3 ÷ 2 bar			

Kit di guarnizioni Seal kit

FULCRO 12	FULCRO 25	FULCRO 45
106-900-00408	106-900-00453	106-900-00506



106-000-00032 PIA.APP.GRP.PMP. PMS-PMI
 MOUNTING PLATE FOR TANK PMS-PMI



106-000-00078 AST. CON IMP.PMS/PMI L.600 MM 35x15
 LEVER FOR PMS/PMI L. 600 MM 35x15



106-000-00247 MAGGIORAZIONE RITORNO A MOLLA X PMS
 SPRING RETURN FOR PMS

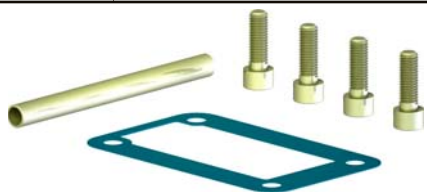

106-960-00700 KIT MONTAGGIO POMPE PMS/PMI
 MOUNTING KIT FOR PUMPS PMS/PMI

Sforzo in fase di pompaggio con leva standard

Load while pumping with standard lever

FULCRO 12

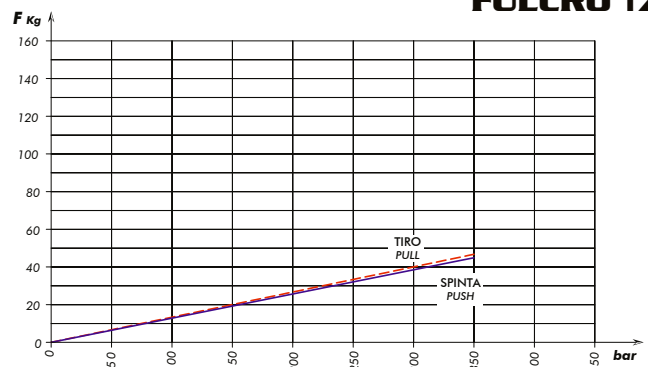

FULCRO 25

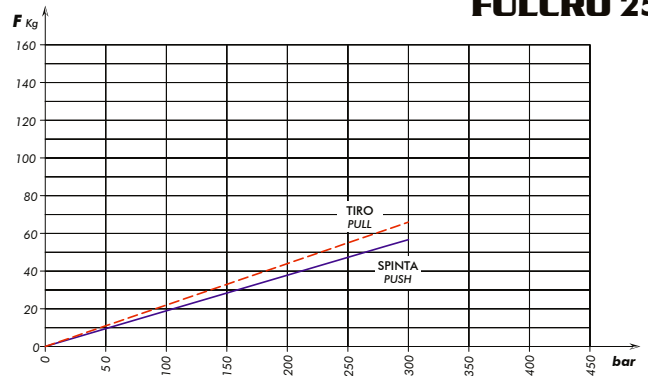

FULCRO 45

